

June 1991

MISSILE PROCUREMENT

AMRAAM's Reliability Is Improving, but Production Challenges Remain

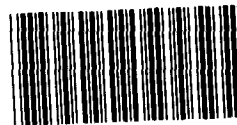
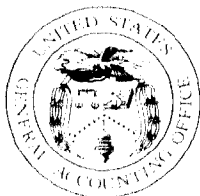

144217

RELEASED

RESTRICTED—Not to be released outside the
General Accounting Office unless specifically
approved by the Office of Congressional
Relations.



United States
General Accounting Office
Washington, D.C. 20548

**National Security and
International Affairs Division**

B-221734

June 20, 1991

The Honorable Sam Nunn
Chairman, Committee on Armed Services
United States Senate

The Honorable Les Aspin
Chairman, Committee on Armed Services
House of Representatives

The Honorable Daniel K. Inouye
Chairman, Subcommittee on Defense
Committee on Appropriations
United States Senate

The Honorable John P. Murtha
Chairman, Subcommittee on Defense
Committee on Appropriations
House of Representatives

This report addresses the status of the Advanced Medium Range Air-to-Air Missile at the scheduled full-rate production milestone. The report concludes that tests have successfully demonstrated additional critical performance requirements and improved reliability, but design and manufacturing changes have disrupted production and that additional tests are needed to measure the missile's operational effectiveness and suitability. The report states that the Congress should reduce the Air Force's and the Navy's fiscal year 1992 budget requests by a total of \$156.2 million for 314 missiles because funding for these missiles can be delayed.

Unless you publicly announce its contents earlier, we plan no further distribution of this report until 5 days after its issue date. At that time, we will send copies to the Secretaries of Defense, the Air Force, and the Navy; the Director, Office of Management and Budget; and other interested parties.

This report was prepared under the direction of Nancy R. Kingsbury, Director, Air Force Issues, who may be reached on (202) 275-4268 if you or your staff have any questions. Other major contributors to this report are listed in appendix I.

Frank C. Conahan
Assistant Comptroller General

Executive Summary

Purpose

The Air Force's and the Navy's budget requests for fiscal year 1992 included almost \$1 billion for the continued procurement of the Advanced Medium Range Air-to-Air Missile. Last year, GAO recommended that the Congress deny the services' billion dollar requests for the missile's procurement in fiscal year 1991 primarily because of uncertainties about the missile's performance and reliability and the delays in missile deliveries.¹

As a result of continued congressional interest, GAO is reporting on the status of the missile program for this year's budget deliberations. Specifically, GAO assessed whether

- operationally realistic tests had demonstrated that the missile would be effective and suitable in combat and
- both contractors had demonstrated the ability to produce quality missiles at the required rates.

Background

The Air Force and the Navy are jointly developing the Advanced Medium Range Air-to-Air Missile to replace the Sparrow missile. The Advanced Medium Range Air-to-Air Missile will be compatible with the services' latest fighter aircraft—F-14, F-15, F-16, F/A-18, and Advanced Tactical Fighter—and is expected to have some key performance improvements over the Sparrow.

The Air Force manages the program. Hughes Aircraft Company is the prime development contractor under a leader-follower acquisition strategy. Raytheon Company is the follower.

The Air Force and the Navy now plan to procure a total of 15,450 missiles—down from 24,320—between fiscal years 1987 and 1999. The total procurement cost is estimated at \$11.8 billion, including inflation, compared to the previous estimate of \$13.5 billion for the 24,320-missile program. Through fiscal year 1991, the Congress has appropriated almost \$4 billion to procure over 3,100 missiles during the first 5 production years.

The National Defense Authorization Act for fiscal years 1990 and 1991 restricts the Air Force from proceeding to full-rate production, which i

¹Missile Procurement: Further Production of AMRAAM Should Not Be Approved Until Questions Are Resolved (GAO/NSIAD-90-146, May 4, 1990).

defined as more than 900 missiles per year, until the Director, Operational Test and Evaluation, certifies that all required testing has been completed, the results demonstrate the missile has met its stated performance requirements, and a stable design, including software, has been established.

In May 1990 GAO reported that significant questions about the missile's performance, reliability, producibility, and affordability remained unresolved. GAO recommended that the Secretary of Defense not approve any additional production until the program had met specific criteria in each unresolved area.

The services' initial budget requests for fiscal year 1992 included \$997 million for 1,191 missiles. In late April 1991 the Air Force's request was reduced by \$115 million and 300 missiles because of contractors' delays in delivering missiles.

Results in Brief

Since GAO's May 1990 report, tests have demonstrated significantly improved missile reliability and additional critical performance requirements. For example, as a result of improvements, the missile's reliability more than doubled, from about 90 flight hours between maintenance in early 1990 to over 200 hours in early 1991. However, the Defense Acquisition Board concluded in May 1991 that additional testing is needed before the missile can enter full-rate production.

In addition, at the completion of GAO's work in April 1991, the contractors' missile deliveries were behind original schedules and many of the problems that had delayed production were not fully resolved. As a result of the delays, the Air Force extended the contractors' delivery schedules. On the basis of the new schedules, GAO believes that \$156.2 million of the \$882 million requested for fiscal year 1992 will not be needed in fiscal year 1992.

Principal Findings

Operational Reliability Has Improved Significantly

The missile's reliability has more than doubled from an average of about 90 hours between maintenance cited in GAO's last report to over 200 hours in ongoing operational tests, which meets the Defense Acquisition Board's reliability requirement for full-rate production. However, the

Air Force had completed only about 60 percent of the test program, which is designed to demonstrate progress toward the 450 hours required after the system has been operational for 2 years.

Additional Critical Performance Requirements Have Been Demonstrated

Since GAO's last report, tests have demonstrated additional critical performance requirements. For example, a May 1990 test showed that a pilot could simultaneously engage four targets with four missiles in a realistic combat environment. Also, a November 1990 test showed that a pilot could simultaneously engage one target with an Advanced Medium Range Air-to-Air Missile and another target with a Sparrow, thus demonstrating that the two missiles do not interfere with each other during flight.

Additional Testing Needed for Full-Rate Production Approval

In May 1991 the Defense Acquisition Board assessed the Advanced Medium Range Air-to-Air Missile's operational effectiveness, suitability, and lethality as part of its deliberations on the missile's readiness for full-rate production. The Board concluded that questions remain about the missile's effectiveness after being carried on operationally realistic flights and the lethality of the missile's warhead. Additional testing in these areas was planned but not yet accomplished. Consequently, the Board recommended that the missile remain in low-rate production.

Production Delays Reduce Funding Needs

At the time of GAO's May 1990 report, both contractors were at least 6 months behind their approved delivery schedules. Since that time, design and manufacturing changes have caused their deliveries to fall even further behind, and the Air Force has extended the contractors' delivery schedules. Consequently, GAO estimates that \$156.2 million for 314 missiles requested for fiscal year 1992 is not needed. Unless both contractors substantially increase their deliveries, the amount of unneeded funds will increase.

Matter for Congressional Consideration

Because of delays in production and consequent lower funding requirements for fiscal year 1992, GAO believes that the Congress should reduce the services' \$882 million request for fiscal year 1992 by \$156.2 million.

Recommendation

GAO recommends that the Secretary of Defense monitor the contractors' progress in meeting the current production schedules and, if their deliveries fall further behind, reduce missile quantities procured under subsequent contracts.

Agency Comments

As requested, GAO did not obtain official agency comments on this report. However, GAO discussed a draft of this report with officials responsible for managing the program at the Office of the Secretary of Defense, the Air Force, and the Navy and incorporated their comments where appropriate.

Contents

Executive Summary

Chapter 1

Introduction

AMRAAM's Production History	1
Recent GAO Reports	1
Objectives, Scope, and Methodology	1

Chapter 2

Additional Testing Considered Necessary for Full-Rate Production Decision

Testing Required for Full-Rate Production	1
Ongoing Tests Show Reliability Improvements	1
Additional Critical Performance Issues Demonstrated	1
Additional Testing Considered Necessary by the Defense Acquisition Board	1
Conclusion	1

Chapter 3

Continuing Production Delays Reduce Funding Needs

Contractors Fall Further Behind Planned Delivery Schedules	1
Reasons for Production Delays	2
Continuing Delays Will Reduce Fiscal Year 1992 Funding Needs	2
Conclusion	2
Matter for Congressional Consideration	2
Recommendation	2

Appendix

Appendix I: Major Contributors to This Report	2
---	---

Related GAO Products

Table

Table 1.1: AMRAAM Procurement Quantities and Funding Requirements	1
---	---

Figures

Figure 1.1: The AMRAAM	
Figure 3.1: Hughes' Scheduled and Actual Second-Year Missile Deliveries as of April 1991	2
Figure 3.2: Raytheon's Scheduled and Actual Second-Year Missile Deliveries as of April 1991	2
Figures 3.3: Hughes' Scheduled and Actual Cumulative Missile Deliveries as of April 1991	2

Figure 3.4: Raytheon's Scheduled and Actual Cumulative
Missile Deliveries as of April 1991

28

Abbreviations

AMRAAM Advanced Medium Range Air-to-Air Missile
GAO General Accounting Office

Introduction

The Air Force and the Navy are jointly developing the Advanced Medium Range Air-to-Air Missile (AMRAAM) to meet their air-to-air missile requirements into the next century. The primary goal of the AMRAAM program is to produce an all-weather, medium range missile that will enable a pilot to simultaneously engage multiple aircraft in combat. The missile is to destroy targets both within and beyond a pilot's visual range and is to be compatible with both services' latest fighter aircraft: F-14, F-15, F-16, F/A-18, and Advanced Tactical Fighter. The AMRAAM, as shown in figure 1.1, is about 12 feet long and weighs about 345 pounds.

Figure 1.1: The AMRAAM

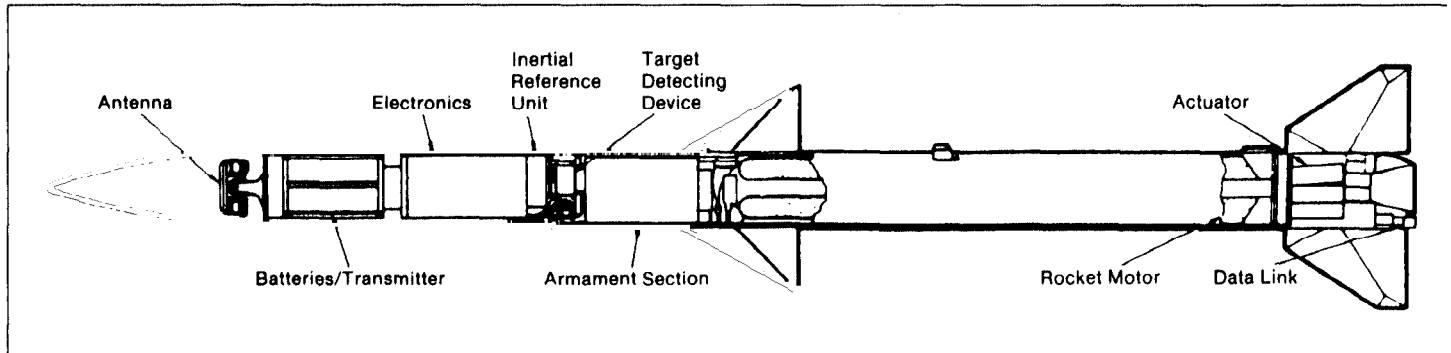

AMRAAM is to replace the Sparrow missile, several versions of which have been in production for the Air Force, the Navy, and numerous foreign countries since the late 1950s. AMRAAM is intended to improve aircraft combat effectiveness and to be more reliable and maintainable than the Sparrow. Its improved performance features over the Sparrow include higher speed, greater range, increased maneuverability, and better resistance to electronic countermeasures. Unlike the Sparrow, which has a semiactive seeker that requires the launch aircraft to illuminate the target with its radar until missile impact, AMRAAM has an active terminal seeker that enables the missile's on-board radar to acquire a target and guide it to the target autonomously. This important feature, together with the launch aircraft's radar, enables a pilot to track multiple targets, launch multiple missiles, and maneuver the aircraft to avoid counterattack. AMRAAM is designed to guide close to the target and detonate its warhead within lethal range of the target.

As the lead procuring service, the Air Force manages the program from a Joint System Program Office located at Eglin Air Force Base, Florida. Hughes Aircraft Company is the prime development contractor under a

leader-follower acquisition strategy. During full-scale development, Raytheon Company (the follower) monitored the Hughes' design effort and produced 15 missiles to qualify as a second producer.

Through fiscal year 1991, the Congress had appropriated about \$4 billion to procure over 3,100 missiles in the first 5 years of production. Hughes is under contract to produce 105, 223, and 534 missiles over the first 3 years of production. For the same period, Raytheon is under contract to produce 75, 200, and 372 missiles. Each contractor is to produce 450 of the 900 total missiles that are planned for the fourth year. The Air Force has authorized funds for long-lead items and plans to complete the contracts in May 1991. Hughes and Raytheon are to bid competitively for the fifth and each succeeding production year, with the winner receiving a larger share of the procurement quantity.

The Air Force's and the Navy's initial budget requests for fiscal year 1992 included \$997 million for 1,191 missiles. In late April 1991 the Air Force's request was reduced by a total of \$115 million and 300 missiles because the contractors were behind in delivering production missiles.

In March 1991 the Acting Under Secretary of Defense for Acquisition approved significant reductions to the Air Force's and the Navy's total and annual planned procurement quantities. The total procurement quantity decreased from 24,320 to 15,450 as a result of new threat assessments. The annual procurement quantities also dropped sharply, from 3,000 missiles to about 1,500. Program officials told us the lower annual quantities were required because AMRAAM's portion of the declining defense budget was not adequate to sustain the higher quantities. Table 1.1 shows AMRAAM procurement quantities and funding requirements for fiscal years 1992 through 1999.

Table 1.1: AMRAAM Procurement Quantities and Funding Requirements

Dollars in millions with inflation

Fiscal year	Procurement	
	Quantity	Funding
1992	891	\$88
1993	1,469	1,01
1994	1,475	93
1995	1,608	95
1996	1,425	87
1997	1,720	1,00
1998	2,008	1,09
1999	1,451	89

The new procurement plans decreased total procurement costs but significantly increased projected unit costs. AMRAAM's December 1989 Department of Defense Selected Acquisition Report showed that, with inflation, the Air Force and the Navy expected to spend a total of \$13.5 billion to procure 24,320 missiles over a 12-year period ending in 1998. The December 1990 report showed the services expected to spend \$11.8 billion for 15,450 missiles over a 13-year period ending in 1999. AMRAAM's quantity was reduced 36 percent while its estimated procurement cost was reduced only 13 percent primarily because of inflation and fixed costs for the additional procurement year. Considering the research and development cost, AMRAAM's total acquisition cost, with inflation, has decreased from \$14.9 billion to \$13.1 billion, or only about 12 percent. AMRAAM's unit acquisition cost, however, has increased 39 percent, from \$612,064 to \$848,699, because the lower total acquisition cost is spread over the much lower procurement quantity.

AMRAAM's Production History

Major defense system acquisition programs typically proceed through several phases. Each phase is preceded by a senior management review at the military service and/or the Department of Defense level. These reviews are referred to as "milestone decisions." Frequently, the Department of Defense and the military services divide the final phase, the production decision, into two increments: milestones "IIIA" and "IIIB." Milestone IIIA is for low-rate initial production, which is to provide articles for additional testing and to allow contractors to demonstrate manufacturing techniques and controls. The milestone IIIB decision is to authorize full-rate production.

In June 1987 the Secretary of Defense approved funding for the first year of AMRAAM low-rate production. After a May 1988 review by the Defense Acquisition Board, the Secretary approved the second low-rate production year. In May 1988 the Board also reviewed the Air Force's request to procure long-lead items for the third production year—which was to be the first year of full-rate production—but decided to defer its decision until more test data were available. In September 1988 the Board's Conventional Systems Committee decided that the program was not ready for full-rate production and approved release of long-lead funding for an additional year of low-rate production. In December 1989, citing improved reliability, the Board approved the fabrication of third-year missiles.

In December 1989 the Board also authorized the Air Force to commit some funds for long-lead items and producibility enhancements for the fourth production year but did not authorize the fabrication of missiles. The Board elected to review the program again before deciding on whether the program should proceed into full-rate production. The date for the Board's review slipped from May 1990 to May 1991 primarily because of the need to identify, incorporate, and demonstrate reliability¹ improvements. On May 23, 1991, the Board reviewed AMRAAM's readiness for full-rate production and decided to authorize continued low-rate production through the sixth year of production, pending completion of certain tests and reporting requirements on testing.

Hughes completed its 105 first-year missiles in January 1990, and Raytheon completed its 75 missiles in January 1991. As of April 1991 Hughes had almost completed its second-year deliveries, Raytheon was delivering second-year missiles, and both contractors were reworking first-year missiles to incorporate improvements and correct deficiencies.

Recent GAO Reports

In September 1989 we reported² that AMRAAM was not ready to proceed into full-rate production. The report cited performance requirements that had not been demonstrated, reliability that was unacceptable, and continued design changes that were disrupting missile production and deliveries from both contractors. We recommended that the Secretary of Defense not authorize AMRAAM for full-rate production until realistic

¹ AMRAAM's reliability is measured primarily by the number of hours the missiles are carried on an aircraft before they have to be returned for maintenance.

² Missile Procurement: AMRAAM Not Ready for Full-Rate Production (GAO/NSIAD-89-201, Sept. 7, 1989).

tests demonstrate that the missile will be effective and reliable, the design stabilizes, and the production readiness reviews show that the contractors can produce quality missiles at the required rates. The Secretary concurred with our recommendation.

In May 1990 we reported³ that significant questions about AMRAAM's performance, reliability, producibility, and affordability remained unresolved. We recommended that the Secretary of Defense not approve any additional AMRAAM production until (1) tests demonstrate that the missile can meet all of its critical performance requirements and that its reliability meets the established requirements, (2) both contractors demonstrate that they can consistently produce quality missiles at the rate required by their contracts, (3) the Air Force and the Navy complete their review of missile quantity requirements, and (4) the Department of Defense determines that the AMRAAM program is affordable within realistic future budget projections. We also suggested that the Congress deny the \$1.34 billion requested for AMRAAM procurement in fiscal year 1991. The Secretary partially concurred with our recommendation and stated that not approving additional AMRAAM production until both contractors demonstrate that they can consistently produce quality missiles at required rates may not be in the best interest of the government. The Congress subsequently reduced the fiscal year 1991 budget request for AMRAAM by \$500 million.

Objectives, Scope, and Methodology

As a result of continued congressional interest, we are reporting on AMRAAM's status before the Senate and House Committees on Armed Services and the Senate and House Subcommittees on Defense, Committees on Appropriations, complete work on the fiscal year 1992 budget request. Specifically, we assessed whether

- operationally realistic tests had demonstrated that AMRAAM would be effective and suitable in combat and
- both contractors had demonstrated the ability to produce quality missiles at the required rates.

We obtained information from records and officials primarily within the AMRAAM Joint System Program Office located at Eglin Air Force Base, Florida. We also discussed AMRAAM's status and testing issues with officials in the following organizations.

³Missile Procurement: Further Production of AMRAAM Should Not Be Approved Until Questions Are Resolved (GAO/NSIAD-90-146, May 4, 1990).

Office of the Secretary of Defense

- Office of the Under Secretary of Defense for Acquisition
- Director, Operational Test and Evaluation
- Director, Live Fire Test

Department of the Air Force

- Headquarters
- Headquarters, Tactical Air Command
- Systems Command, Development Test Center
- Tactical Air Warfare Center
- Operational Test and Evaluation Center
- 33rd Tactical Fighter Wing

Department of the Navy

- Headquarters, Naval Air Systems Command
- Operational Test and Evaluation Force

Contractors

- Hughes Aircraft Company
- Raytheon Company

To determine whether tests had demonstrated that AMRAAM would be effective and suitable in combat, we reviewed test reports, compared planned and actual test schedules, and correlated the individual test results with the critical performance issues. We examined the results of reliability flight tests, various ground tests, and air-to-air missile firings. We also witnessed selected guided flight tests and discussed test results with Air Force, Navy, and Office of the Secretary of Defense officials responsible for conducting and monitoring the tests.

To assess the contractors' ability to produce quality missiles at the required rates, we focused on the Air Force's and the contractors' plans for identifying and incorporating design and manufacturing process improvements. This included results of Air Force, contractors', and independent reviews of AMRAAM's technical description; quality and process controls at the prime and the major subcontractors; additional production acceptance tests; and improved manufacturing screens at the lower assembly levels. We reviewed the component qualification tests, the engineering change proposals, and the deviations and waivers. We also

visited both Hughes and Raytheon to get their first-hand assessments of the progress and the problems.

We conducted our review from September 1990 through April 1991 in accordance with generally accepted government auditing standards. As requested, we did not obtain official agency comments on this report. However, we discussed a draft of this report with officials responsible for managing the program at the Office of the Secretary of Defense, the Air Force, and the Navy and incorporated their comments where appropriate.

Additional Testing Considered Necessary for Full-Rate Production Decision

Since our May 1990 report, AMRAAM's reliability has more than doubled and has met the Defense Acquisition Board's requirement for full-rate production. For example, improved missiles averaged over 200 flight hours between maintenance, a significant improvement over the 90-hour average cited in our last report. However, the Air Force has completed only about 60 percent of the current test program, which is to demonstrate progress toward the 450 hours required after the system has been operational for 2 years.

Tests have also demonstrated additional AMRAAM performance requirements since our last report. However, after reviewing the program in May 1991, the Board withheld approval of full-rate production for AMRAAM pending (1) further tests and required reports on the missile's operational effectiveness, suitability, and lethality and (2) completion of requirements for congressional certification.

Testing Required for Full-Rate Production

Several statutes governing major system acquisitions stipulate that systems, like AMRAAM, may not proceed beyond low-rate initial production until (1) initial operational test and evaluation is completed to determine whether the system will be effective and suitable when it is used under realistic, combat-like conditions; (2) the Director, Operational Test and Evaluation, assesses the system's operational effectiveness and suitability and reports the results to the Secretary of Defense and to the Senate and House Committees on Appropriations and on Armed Services; and (3) realistic survivability or lethality testing of the system is completed and the Secretary of Defense submits a report on the testing to the defense committees of the Congress.

In addition, the National Defense Authorization Act for fiscal years 1990 and 1991 includes a provision that restricts the Air Force from proceeding to full-rate production—defined as that in excess of 900 missile per year—until the Director, Operational Test and Evaluation, certifies that all required testing has been completed, the results demonstrate the missile has met all established performance requirements, and a stable design, including software, has been established.

Ongoing Tests Show Reliability Improvements

From December 1990 to February 1991 AMRAAM averaged 200 hours between maintenance after 1,000 flight hours on the F-15 aircraft. This is more than double the 90-hour average cited in our last report. The Board decided in May 1991 that the 200-hour average satisfied its reliability requirement established for the full-rate production decision. The

increase in reliability was achieved using improved missiles. AMRAAM's next reliability hurdle is 450 hours between maintenance, which is required 2 years after AMRAAM achieves its initial operational capability.¹ Progress toward this requirement will be reviewed at the completion of a 3,200-flight hour program on the F-15 aircraft.

Over the years, there have been several attempts to demonstrate AMRAAM's reliability requirements. The Air Force has attributed AMRAAM's reliability problems to the more-severe-than-expected environment encountered when carried on the F-15 aircraft. Our May 1990 report showed AMRAAM had achieved about a 90-hour average time between maintenance after about 895 flight hours on the F-15 aircraft. This average was far short of the Board's 200-hour requirement. Our report also noted that, as a result of the reliability problems, the Air Force stopped accepting missiles from both contractors in February 1990.

As a result of the continuing reliability problems, the Board, in April 1990, directed the Air Force to develop a corrective action and reliability improvement plan. The plan approved by the Board in August 1990 provided for extensive ground and flight tests to identify changes to improve the quality of Hughes and Raytheon missiles and the components they purchase from key subcontractors. These tests have identified the need for some 160 design and manufacturing process changes, improved quality inspections, and more intensive production tests designed to ensure that the missiles can withstand the F-15 environment. The Air Force resumed accepting missiles in August 1990 because of increased confidence in missile quality.

In December 1990 the Air Force's independent operational test organization began the current 3,200-hour AMRAAM reliability test program on the F-15 aircraft using missiles containing most of the reliability improvements. According to an Air Force test official, the test missiles include upgrades that make them representative of missiles that are to be produced early in the third production year. In February 1991 after 1,000 flight hours on the F-15 aircraft, AMRAAM achieved a 200-hour average time between maintenance, which is the reliability criterion for full-rate production established by the Board in December 1989.

¹The Air Force currently expects AMRAAM to achieve its initial operational capability during the fourth quarter of fiscal year 1991 (July to September 1991).

As of April 1991, AMRAAM averaged about 296 hours between maintenance in the first 2,073 flight hours on the F-15 aircraft.² Although the 296-hour average represented a significant reliability improvement, officials at the Air Force's independent test organization told us that the remainder of the 3,200-hour program would be required to improve statistical confidence in the test results. In addition, they told us that the entire test program must be completed before the results could be used to project AMRAAM's progress toward the 450-hour minimum requirement. This requirement must be achieved within 2 years after AMRAAM is declared operational. Air Force test officials project that the tests will be completed about August 1991.

Both the Air Force and the Navy also have ongoing reliability programs on the F-16 and F/A-18 aircraft, respectively. As of April 1991, the F-16 program had experienced four failures after 658 hours, for an average of 165 hours between maintenance. The F/A-18 program had one failure after 446 hours.

Additional Critical Performance Issues Demonstrated

Tests have successfully demonstrated additional AMRAAM critical performance requirements that were outstanding at the time of our last report. In May 1990 a pilot simultaneously engaged four targets with four AMRAAMS. Despite the presence of electronic countermeasures intended to confuse the aircraft's and the missiles' radars, three missiles scored direct hits and the fourth passed its target within the warhead's lethal range. To demonstrate that AMRAAM and Sparrow do not interfere with each other's performance, in November 1990 a pilot simultaneously engaged one target with an AMRAAM and another with a Sparrow. The Sparrow scored a direct hit while the AMRAAM passed its target within the warhead's lethal range. In January 1991 a Raytheon-built AMRAAM with a warhead scored a direct hit on a maneuvering target. In February 1991 the Air Force announced that AMRAAM was operational in the Middle East in support of Operation Desert Storm.

²An additional failure was under consideration that could decrease the average to 259 hours between maintenance.

Additional Testing Considered Necessary by the Defense Acquisition Board

Interim assessments of AMRAAM's operational effectiveness, suitability, and lethality were presented to the Board for its review of AMRAAM's readiness for full-rate production on May 23, 1991. Those assessments questioned the effectiveness of missiles that have been carried on operationally realistic flights and the lethality of AMRAAM's warhead. Additional flight tests to address these issues are scheduled over the coming months.

The Director, Operational Test and Evaluation, has been concerned since at least 1988 that missiles used in the captive carry program to test for reliability were not subsequently used in the guided flight tests. The Air Force's current test plan includes several guided flight tests to demonstrate various aspects of AMRAAM's performance. Some of the missiles to be used in these tests are to be captive carry missiles. As of April 1991, however, the Air Force's independent operational test organization had completed only 3 of the 19 currently planned tests, and none of the missiles used had any captive carry time. Two of these tests were successful; one was the previously discussed test of AMRAAM's and Sparrow's compatibility, and the other demonstrated the AMRAAM's minimum visual launch range. However, during the third test the missile began to break apart and tumble out of control almost immediately after launch. According to Air Force and contractor officials, the failure was most likely caused by a component that is unique to test missiles and would not affect missiles being delivered to operational forces.

Over the past several years, tests have been conducted to assess the lethality of AMRAAM's warhead. However, the Director, Live Fire Test, has determined that the data on those tests do not support a determination that the warhead's lethality is acceptable. Some of the tests in the Air Force's current test plan, and some of the tests in the Navy's current operational test plan, are to address the effectiveness and the lethality of AMRAAM's warhead. However, none of those tests has been successfully completed to date.

Conclusion

Since our last report, AMRAAM's reliability has more than doubled and additional critical performance capabilities have been demonstrated. However, the Defense Acquisition Board has determined that additional tests are required to demonstrate AMRAAM's readiness for full-rate production.

Continuing Production Delays Reduce Funding Needs

At the time of our May 1990 report, both contractors were at least 6 months behind their approved delivery schedules. Since that time, design and manufacturing changes have caused their deliveries to fall even further behind, and the Air Force has extended the contractors' delivery schedules. Consequently, \$156.2 million for 314 missiles requested for fiscal year 1992 is not needed. Unless both contractors substantially increase their deliveries, the amount of unneeded funds will increase.

Contractors Fall Further Behind Planned Delivery Schedules

Neither contractor had demonstrated the ability to consistently produce quality AMRAAMS at required rates, although both contractors had increased deliveries during February and March 1991. At the time of our last report, both contractors were at least 6 months behind their approved delivery schedules. Hughes is to complete its second-year deliveries in May 1991, about 9 months late, and according to the Air Force's latest schedule assessment, Raytheon is to complete its second-year deliveries in August 1991, about 11 months late. Both contractors should have started delivering third-year missiles in August 1990. Figures 3.1 and 3.2 show the contractors' scheduled and actual second-year missile deliveries through April 1991.

Chapter 3
Continuing Production Delays Reduce
Funding Needs

Figure 3.1: Hughes' Scheduled and Actual Second-Year Missile Deliveries as of April 1991

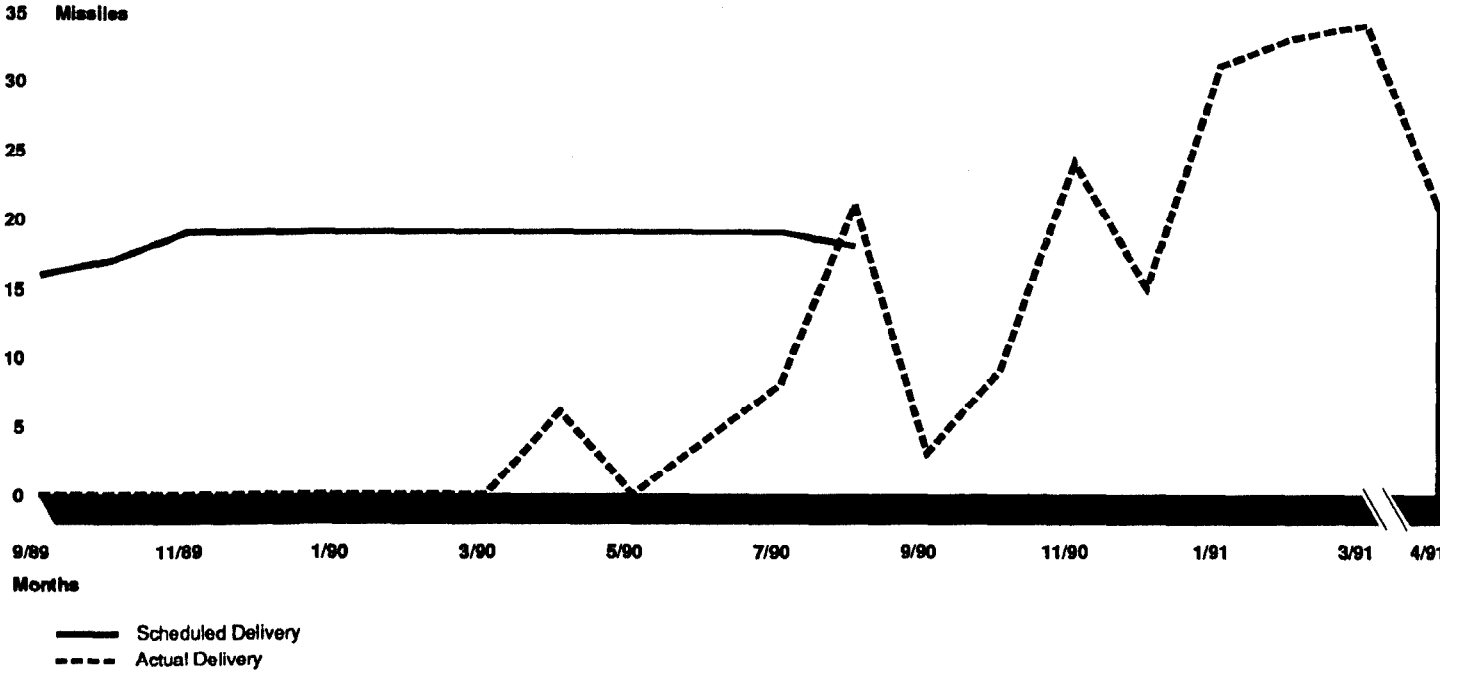
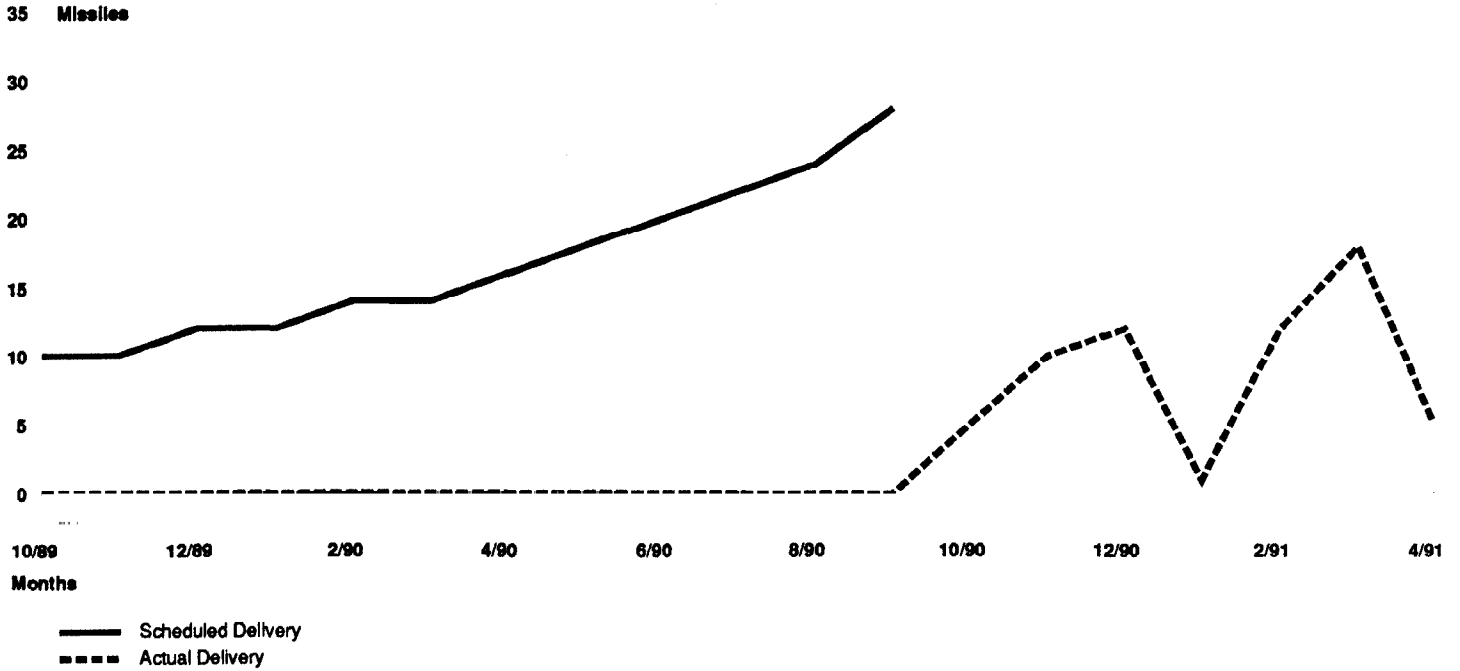

Figure 3.2: Raytheon's Scheduled and Actual Second-Year Missile Deliveries as of April 1991



Production delays have created a significant production backlog. Through April 1991 Hughes had delivered only 314 of the 701 missiles planned when the contracts for the first 3 production years were awarded. Raytheon had delivered only 138 of the 551 missiles under its original contracts. Figures 3.3 and 3.4 show the contractors' scheduled and actual cumulative missile deliveries in 3-month increments.

Figures 3.3: Hughes' Scheduled and
Actual Cumulative Missile Deliveries as
of April 1991

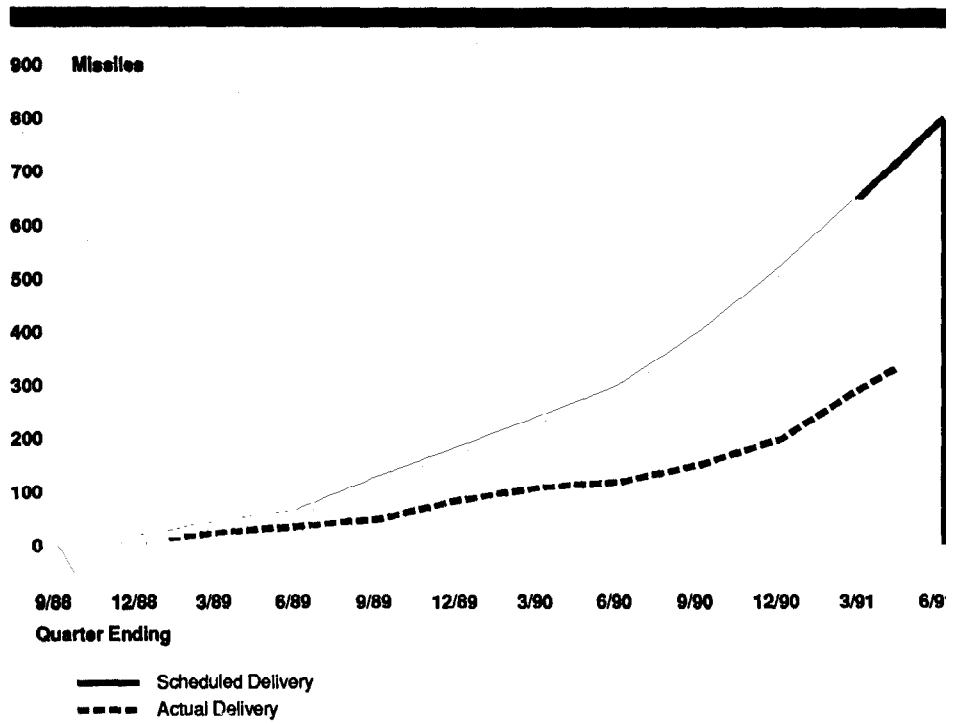
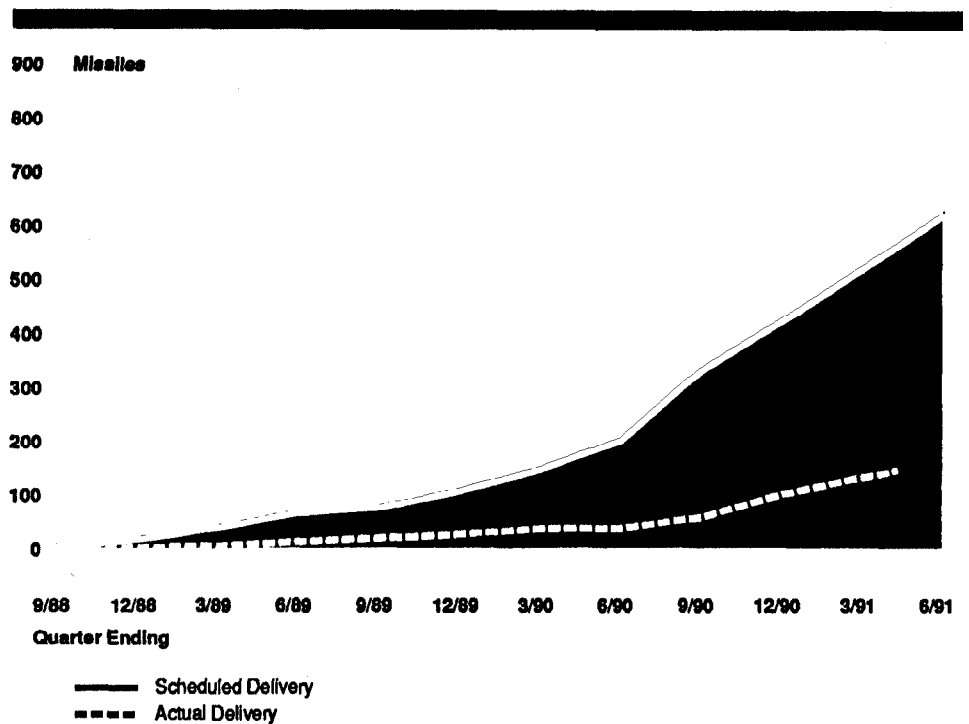

Figure 3.4: Raytheon's Scheduled and Actual Cumulative Missile Deliveries as of April 1991



Reasons for Production Delays

Last year we reported that the Air Force had stopped accepting missiles in February 1990 because of significant reliability problems. The Air Force did not resume accepting missiles until August 1990 when needed corrective actions were identified and mostly implemented. These corrective actions further delayed missile deliveries because more rigorous tests found numerous defects that required missiles to be reworked several times. Despite these actions, many of the missiles subsequently delivered to the Air Force experienced problems and required rework.

Between February and August 1990, Hughes and Raytheon implemented an extensive reliability improvement plan. The plan provided for tests that identified some 160 changes that included improved quality inspections and more rigorous production tests.

The new production tests, however, caused production delays in that numerous defects were found in almost all missiles tested. Although these tests were envisioned as discrete final tests, they almost always

resulted in a test-troubleshoot-repair-retest process. This time-consuming process often had to be repeated several times along the production line. Tests at the end of the production line often required several weeks to complete. At the time of our plant visits in January and April 1991, both contractors were attempting to isolate and correct defects earlier in the production process to avoid having to disassemble major missile components.

Despite the rigorous tests, additional problems have been found in missiles delivered since August 1990. For example, shortly after missile deliveries were resumed in August 1990, weld cracks were found in warheads provided to both contractors from a common subcontractor. As a result, additional missiles could not be delivered by either prime contractor until the warheads were reworked. In addition, all previously delivered missiles with warheads had to be returned to the factory for inspection and rework.

During January 1991 the Air Force found that two Raytheon missiles did not have the internal pressure required for the missile to perform properly. An investigation determined that, to ensure a proper seal, Raytheon had to implement a process change that Hughes had implemented earlier. The problem prevented almost all January deliveries because the missiles had to be reworked. Additionally, Raytheon had to recall and rework all missiles delivered to the Air Force for the inventory and flight tests through December 1990.

Continuing Delays Will Reduce Fiscal Year 1992 Funding Needs

Defense budget guidance specifies that the services' annual procurement budget requests should fund no more than 12 months of deliveries. This 12-month period is referred to as the funded delivery period. Funds for deliveries beyond this period should not be requested until required. The funded delivery period is usually preceded by the lead time needed to negotiate and award a contract and procure raw materials and components.

Historically, AMRAAM's lead time has been 21 months. Considering the lead time, AMRAAM's funded delivery period for fiscal year 1992 is June 1993 through May 1994. However, Air Force budget documents supporting the fiscal year 1992 budget request show that 314 of the 891 missiles are expected to be delivered between June 1994 and November 1994—6 months beyond the funded delivery period.

The 314 missiles fall beyond the funded delivery period because the Air Force extended the contractors' delivery schedules for the earlier production years when the contractors failed to meet their contractual delivery schedules. However, because many of the problems that have delayed production have not been fully resolved, even the extended schedules appear optimistic. For example, Hughes averaged 30 missiles a month during the first 4 months of 1991. However, the modified contracts require Hughes to deliver 45 missiles in May 1991 and each month thereafter. Raytheon's new schedule may be more difficult to achieve. For example, Raytheon averaged 9 missiles a month during the first 4 months of 1991. However, Raytheon must deliver 32 missiles in May 1991, 38 missiles in August 1991, and 46 missiles per month thereafter. Unless the contractors can achieve and maintain these rate increases, additional missiles will be delivered beyond the funded delivery period.

According to Air Force estimates, reducing the fiscal year 1992 budget by 314 missiles would equate to a potential reduction of \$156.2 million. Program office officials said the estimate considers the unit cost increase caused by allocating the fixed costs over a smaller missile quantity. The estimate appears reasonable, but we did not do a detailed verification.

Conclusion

Although both contractors have implemented extensive corrective actions and reliability improvements, neither has demonstrated the ability to consistently deliver quality missiles at the increasing rates required by their contracts. As a result, the production backlog has continued to grow. In recognition of the delays, the Air Force has extended both contractors' delivery schedules. However, even assuming that the contractors will meet these revised schedules, the Air Force does not expect delivery of 314 of the 891 missiles requested for fiscal year 1992 until the funded delivery period for fiscal year 1993. The Air Force's estimated cost for these missiles is about \$156.2 million. If the contractors cannot meet the current delivery schedules, more missiles will slip to the fiscal year 1993 delivery period. Thus, funds for these missiles would not be needed for fiscal year 1992.

Matter for Congressional Consideration

Because of delays in production and consequent lower funding requirements for fiscal year 1992, we believe the Congress should reduce the services' \$882 million request for AMRAAM production for fiscal year 1992 by \$156.2 million.

Recommendation

We recommend that the Secretary of Defense monitor the contractors' progress in meeting the current production schedules and, if their deliveries fall further behind, reduce missile quantities procured under subsequent contracts.

Major Contributors to This Report

**National Security and
International Affairs
Division, Washington,
D.C.**

Norman J. Rabkin, Associate Director
Robert L. Pelletier, Assistant Director
William R. Graveline, Assignment Manager

**Atlanta Regional
Office**

Jimmy R. Rose, Regional Management Representative
John L. Grant, Evaluator-In-Charge
Johnnie E. Barnes, Evaluator
Douglas A. Taylor, Evaluator

Related GAO Products

Missile Procurement: Further Production of AMRAAM Should Not Be Approved Until Questions Are Resolved (GAO/NSIAD-90-146, May 4, 1990).

Missile Procurement: AMRAAM Not Ready for Full-Rate Production (GAO/NSIAD-89-201, Sept. 7, 1989).

Missile Development: AMRAAM's Combat Effectiveness at Production Not Fully Tested (GAO/NSIAD-88-186, July 7, 1988).

Missile Development: Development Status of the Advanced Medium Range Air-to-Air Missile (GAO/NSIAD-87-168, Aug. 14, 1987).

Missile Procurement: Advanced Medium Range Air-to-Air Missile Preproduction Test Results (GAO/NSIAD-87-165FS, June 2, 1987).

Missile Procurement: AMRAAM Cost Growth and Schedule Delays (GAO/NSIAD-87-78, Mar. 10, 1987).

Missile Development: Advanced Medium Range Air-to-Air Missile (AMRAAM) Certification Issues (GAO/NSIAD-86-124BR, July 9, 1986).

Missile Development: Advanced Medium Range Air-to-Air Missile Legal Views and Program Status (GAO/NSIAD-86-88BR, Mar. 28, 1986).

Missile Development: Status of Advanced Medium Range Air-to-Air Missile (AMRAAM) Certification (GAO/NSIAD-86-66BR, Feb. 18, 1986).

Ordering Information

The first five copies of each GAO report are free. Additional copies are \$2 each. Orders should be sent to the following address, accompanied by a check or money order made out to the Superintendent of Documents, when necessary. Orders for 100 or more copies to be mailed to a single address are discounted 25 percent.

**U.S. General Accounting Office
P.O. Box 6015
Gaithersburg, MD 20877**

Orders may also be placed by calling (202) 275-6241.

